

UNDERGROUND DRUM ELEVATORS & TRAILERS

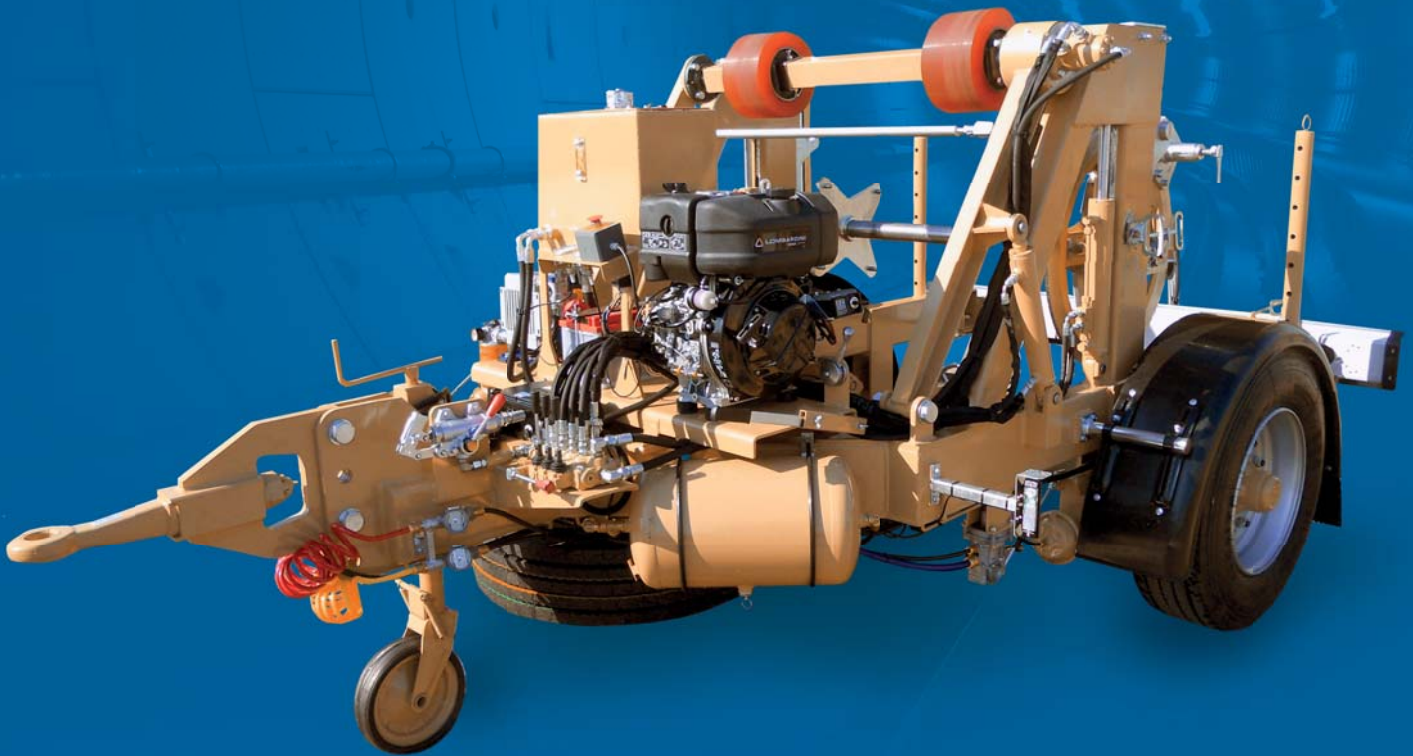

DRUM ELEVATORS & TRAILERS

CODE	TYPE	
CVM	Mechanical Lifting Jacks	13.10
CVM	Mechanical Drum Elevator	13.15
CVM	Hydraulic Drum Elevators Light Duty	13.20
CVB	Hydraulic Lifting Jacks	13.25
CVI/CPR	Hydraulic Drum Elevators & Hydraulic Power Unit	13.30
CVT	Reel Carrier Trailers	13.35
CVT	Reel Carrier Trailers	13.40
CVT	Reel Carrier Trailers	13.45
CVT	Reel Carrier Trailers	13.50

UNDERGROUND DRUM ELEVATORS & TRAILERS

The historical overhead tradition meets the new underground applications

Tesmec offers a big range of machines for drum handling:
 Mechanical models for standard projects
 Hydraulic jacks and elevators for heavy duty applications
 A big range of trailers allowing easier logistic of the drums



TRAILERS

CVT: Trailer solution

- + Hydraulic lifting system
- + Mechanical breaking system or hydraulic with on board engine option
- + Big choice of models according to size and weight of the reels

The best choice for the underground projects, including few models EU type approved.



ELEVATORS

CVI: detachable frame for easy transport

A showcase with a lot of models.
 Customized models available on demand.

CVM

MECHANICAL LIFTING JACKS

The pinion and the crow gear are made by high quality forged steel.
 The lifting system is made by a ratchet wheel with a double retaining catch.
 The load can be applied on both end.
 Racks are totally maintenance free.
 Note: the item is equipped with 1 mechanical lifting jack.
 2 CVM are required for reel lifting.

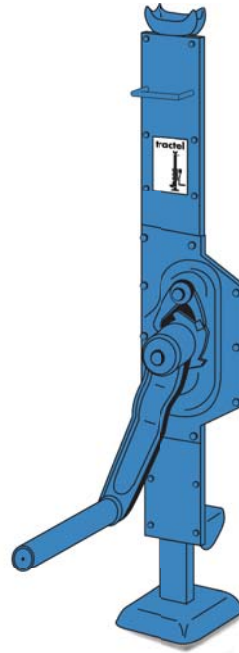

MODEL	CAPACITY [kN]	STANDARD LIFTING [mm]	EFFORT ON HANDLE [Kg]	HEIGHT CLOSED RACK [mm]	MIN. LIFTING HEIGHT [mm]	LIFTING TOE LENGTH [mm]	CRANK HANDLE LENGTH [mm]	MASS [kg]
CVM212	30	355	35	735	70	61	250	20
CVM410	50	345	40	735	80	71	250	28
CVM805	100	390	58	800	100	86	300	46

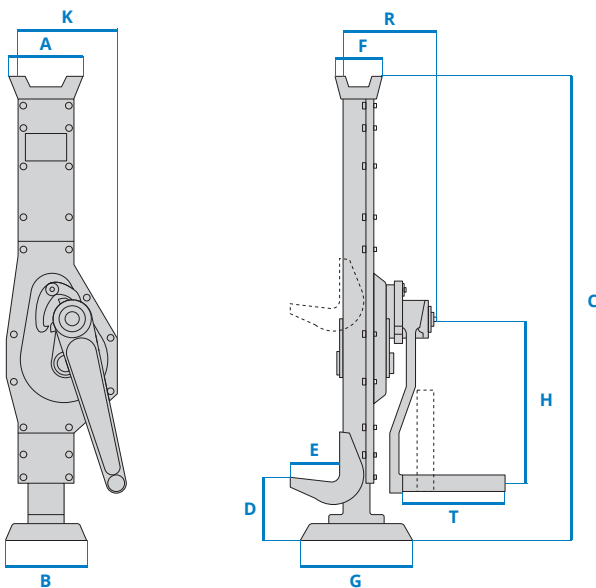

Pictures & drawings can be different according to technical specifications - updating programme variations without notice are possible.

Certified Quality System
ISO 9001:2015

Certified Environmental System
ISO 14001:2015

Certified Health & Safety System
ISO 45001:2018



CVM

MECHANICAL DRUM ELEVATOR

Mechanical drum trestles with adjustable position.

Each jacks lift by a screw operated by a crank handle.

Wide base support assures the reel stability.

The length of screw is suitable to different reel dimensions.

Made of highly galvanized steel to lift reels of diameter between 400 and 3000 mm.

Note: the item is equipped with 2 mechanical drum trestles.

MODEL	CAPACITY [Kg]	REEL DIAMETER [mm]	HEIGHT [mm]	MASS [Kg]
CVM007	1500	400 - 1800	74	30
CVM205	3000	700 - 2600	100	64
CVM407	5000	930 - 3000	130	70
CVM802	10000	1160 - 3000	130	88

ACCESSORIES



ALLOY TUBULAR SHAFT WITH BEARINGS

MODEL	LENGTH [mm]	Ø [mm]	CAPACITY [Kg]	MASS [Kg]
CDS031	1800	90	10000	22.2
CDS032	2050	90	10000	25.3
CDS027	1500	75	5000	14.6
CDS028	1800	75	5000	18.5
CDS029	2050	75	5000	19.6



GALVANISED STEEL TUBULAR SHAFT WITH BALL-BEARING

MODEL	LENGTH [mm]	Ø [mm]	CAPACITY [Kg]	MASS [Kg]
CDS038	1800	90	10000	22.2
CDS039	2050	90	10000	25.3
CDS033	1500	60	3000	18
CDS034	1500	75	5000	14.6
CDS035	1800	75	5000	18.5
CDS036	2050	75	5000	19.6



GALVANISED COLLAR

MODEL	AXLE Ø [mm]	MASS [Kg]
CDO040	60	1.2
CDO041	75	1.5
CDO042	90	1.7



COUPLE OF GALVANISED FIXING CONES

Model	Ø [mm]	Axle Ø [mm]	Mass [Kg]
CDO044	85 - 130	75	7
CDO045	110 - 150	90	8.5
CDO043	65 - 115	60	3

CVM417

MECHANICAL DRUM TRESTLES

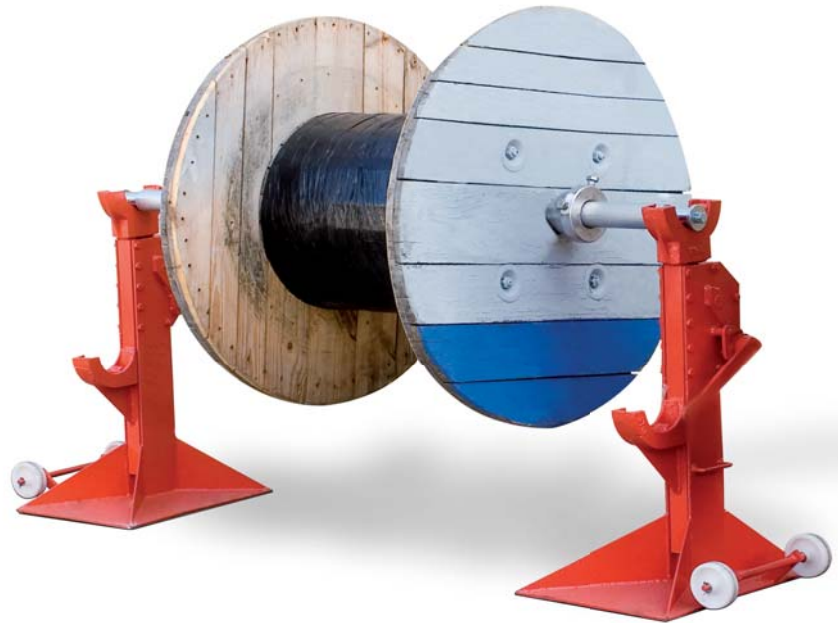

MODEL	CAPACITY [Kg]	REEL DIAMETER [mm]	HEIGHT [mm]	MASS [Kg]
CVM417	5000	2400		50

ACCESSORIES



GALVANISED STEEL TUBULAR SHAFT (FIXED CONES INCLUDED)

MODEL	LENGTH [mm]	DIAMETER [mm]
CDS181	1500	60
CDS182	1600	60
CDS183	2000	60
CDS184	2000	80



CVB823

HYDRAULIC LIFTING JACKS

Hydraulic lifting jacks made of welded galvanized steel.

It can be adjusted to lift different diameter drums.

Hydraulic jacks includes high capacity rotating shaft assembled on bearing wheels.

Note: the item is equipped with 2 lifting jacks, 1 shaft and 2 closing clamps.

MODEL	CAPACITY [kN]	DRUM DIAMETER		DIMENSIONS (EACH JACK)	STROKE [mm]	SHAFT DIAMETER [mm]	MASS [Kg]
		Min [mm]	Max [mm]	b x l x h [mm]			
CVB823	400	3400	4600	1500 x 500 x 1700	150	108	500



TUBULAR STEEL DRUM SHAFT

AVAILABLE DEVICES

MODEL	DESCRIPTION	CAPACITY [kN]	REEL WIDTH [mm]
CDB1xx	Support shaft	124	2100
	Diameter 108 x 25 mm	166	2300
	Different shafts are available on request	249	2500
MODEL	DESCRIPTION		
CDB2xx	Wedges or centering bush for shaft suitable for wide range of drum shaft diameter		
MODEL	DESCRIPTION		
CDB3xx	Closing system to adapt different shafts to hydraulic jacks		

CVI816

HYDRAULIC
DRUM ELEVATORS
HEAVY DUTY

DETACHABLE FRAME

EASY TRANSPORT

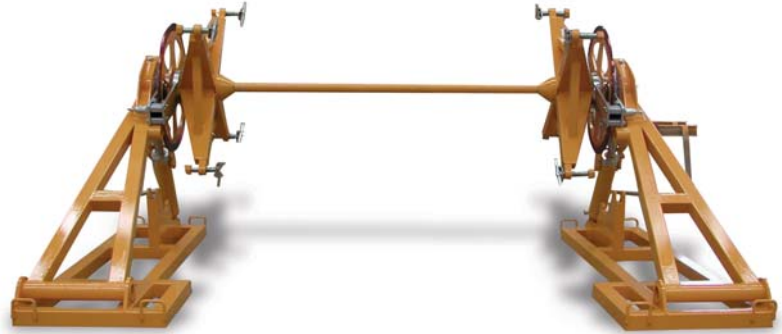

MODEL	DIMENSIONS		SHAFT Ø	CAPACITY	WEIGHT
	Max width	Max Ø			
CVI816	2600 mm	3400 mm	70 mm	160 kN	1340 kg

CVI830/831

HYDRAULIC
DRUM ELEVATORS
HEAVY DUTY

DETACHABLE FRAME

EASY TRANSPORT



MODEL	DIMENSIONS		SHAFT Ø	CAPACITY	WEIGHT
	Max width	Max Ø			
CVI830 CVI831	2800 mm	4450 mm	140 kN	300 kN	1600 kg

CPR

HYDRAULIC
POWER UNIT

COMPATIBLE WITH ALL HYDRAULIC MOTORS
TIH

EASY TRANSPORT

PERFORMANCE

MODEL	OIL FLOW	MAX PRESSURE
CPR202	36 l/min	210 bar
CPR203	20 l/min	210 bar



CVT

REEL CARRIER TRAILERS

SPECIAL MODELS CAN BE DESIGNED ON DEMAND
EC TYPE-APPROVED

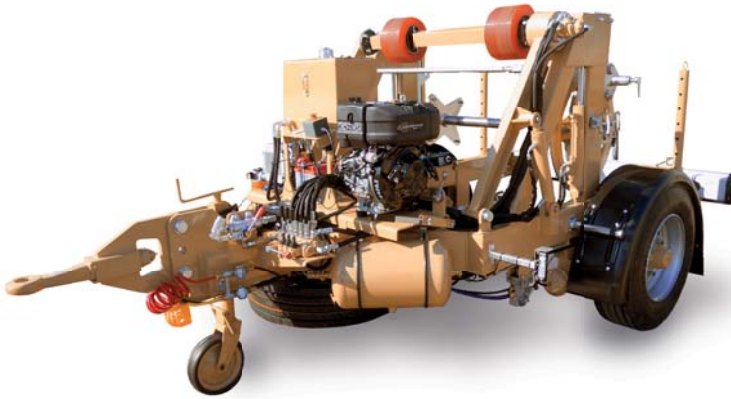

CVT234



CVT415

MOTORIZED MODEL EQUIPPED WITH HYDRAULIC WINDING SYSTEM

MODEL	MAX CAPACITY	ENGINE	REEL DIMENSIONS			MAX TOWING SPEED	OVERALL DIMENSIONS			WEIGHT
			Ø max	Ø min	WIDTH		LENGTH	WIDTH	HEIGHT	
CVT234*	30 kN	8 kW	3000 mm	1400 mm	1300 mm	90 km/h	4300 mm	2200 mm	2000 mm	1700 kg

*EC type-approved for road circulation

TYPICAL AVAILABLE DEVICES FOR CVT234

BOC310 Detachable reel.

STANDARD MODEL

MODEL	MAX CAPACITY	REEL DIMENSIONS			MAX TOWING SPEED	OVERALL DIMENSIONS			WEIGHT
		Ø max	Ø min	WIDTH		LENGTH	WIDTH	HEIGHT	
CVT415*	43 kN	3000 mm	1400 mm	1500 mm	90 km/h	4950 mm	2500 mm	2150 mm	1700 kg

*EC type-approved for road circulation

CONFIGURATION CVT415

Two hydraulic jacks powered by a manual pump are used to lift the reel.
One disc brake acting on the reel shaft is designed to control the unwinding tension.
Manual front plough stabiliser.
Lighting system.
Air brake system.
Amortized semi-axles with mechanical parking brake.

CVT

REEL CARRIER TRAILERS

SPECIAL MODELS CAN BE DESIGNED ON DEMAND

ESSENTIAL LINE



MOTORIZED MODEL EQUIPPED WITH HYDRAULIC WINDING SYSTEM

MODEL	CAPACITY	REEL DIMENSIONS			MAX TOWING SPEED	DIMENSIONS			WEIGHT
		Ø max	Ø min	WIDTH		LENGTH	WIDTH	HEIGHT (Reel excluded)	
CVT249	26 kN	2500 mm	1000 mm	1400 mm	80 km/h	4100 mm	2500 mm	2020 mm	870 kg

STANDARD MODEL

MODEL	CAPACITY	REEL DIMENSIONS			MAX TOWING SPEED	DIMENSIONS			WEIGHT
		Ø max	Ø min	WIDTH		LENGTH	WIDTH	HEIGHT (Reel excluded)	
CVT416	61 kN	3200 mm	1700 mm	1600 mm	80 km/h	4500 mm	2550 mm	2250 mm	1350 kg

Diesel drive on demand

CONFIGURATION

Two hydraulic jacks powered by a manual pump are used to lift the reel.
 Manual front plough stabiliser.
 Air brake system.
 Amortized semi-axles with mechanical parking brake.

CVT610

REEL CARRIER TRAILER

SPECIAL MODELS CAN BE DESIGNED ON DEMAND

DETACHABLE STANDARD HYDRAULIC MOTOR



MODEL	CAPACITY	REEL DIMENSIONS			MAX TOWING SPEED	DIMENSIONS			WEIGHT
		Ø max	Ø min	WIDTH		LENGTH	WIDTH	HEIGHT (Reel excluded)	
CVT610	70 kN	2400 mm	1200 mm	1600 mm	20 km/h	4550 mm	2550 mm	1600 mm	1800 kg

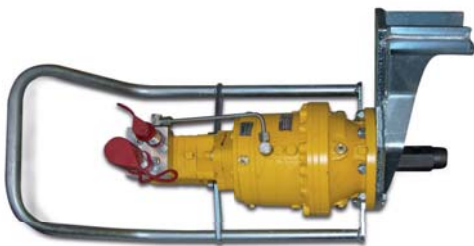

TIH001

TIH

FAST ASSEMBLING HYDRAULIC MOTOR FOR CONTROL OF THE DRUM WINDING AND UNWINDING

CHARACTERISTICS

MODEL	MAX TORQUE	MAX ROTATING SPEED	WEIGHT
TIH001	1.8 kN x m	45 rpm	76 kg

CVT

REEL CARRIER TRAILERS

SPECIAL MODELS CAN BE DESIGNED ON DEMAND

DETACHABLE STANDARD HYDRAULIC MOTOR



STANDARD MODEL

MODEL	CAPACITY	REEL DIMENSIONS			MAX TOWING SPEED	DIMENSIONS			WEIGHT
		Ø max	Ø min	WIDTH		LENGTH	WIDTH	HEIGHT (Reel excluded)	
CVT833	100 kN	3200 mm	1700 mm	1600 mm		4935 mm	2550 mm	2200 mm	1300 kg
CVT835	140 kN 150 kN	3600 mm	2200 mm	1600 mm	20 km/h 15 km/h	4700 mm	2900 mm	2600 mm	2600 kg

Diesel drive on demand

MOTORIZED MODEL EQUIPPED WITH HYDRAULIC WINDING SYSTEM

MODEL	CAPACITY	REEL DIMENSIONS			MAX TOWING SPEED	DIMENSIONS			WEIGHT
		Ø max	Ø min	WIDTH		LENGTH	WIDTH	HEIGHT (Reel excluded)	
CVT836	200 kN	5000 mm	2500 mm	2700 mm	25 km/h	7300 mm	3800 mm	2720 mm	4500 kg



DETACHABLE FOR TRANSPORT

TESMEC S.P.A.
Headquarters
via Zanica, 17/O - 24050 Grassobbio BG - Italy
T +39 035 4232911 F +39 035 4522445

